



Stressless®

New and Improved Stressless® Mary

Improved electrical connections, panel placement and comfort.



Stressless® Mary v2

1. Improved seat comfort & looks (May/June 2023)

Change from flat to curved Flexo-springs as well as increased foam density.



Flat Flexo-springs in the seat have been replaced by curved versions. These are suspended onto a frame which is wider than the spring; increasing flexibility and allowing more movement, helping the seat maintain its shape.



The top cushion on Stressless® Mary is now firmer than the original version (changed from 28 kg/m³ to 30 kg/m³). A higher density of the foam helps the top cushion keep its shape and reduce leather stretching.

2. New button placement

Always placed next to armrest, to avoid hard parts in the centre of the sofa.

3. Improved Power Supply and Battery

Only one power supply/battery needed per 3 Power seats.



New button placement on modules with armrest right

- 1 seat with armrest left or right will always have the control panel at the side of the seat cushion next to the armrests.
- This improves the seating comfort by eliminating a hard component in the centre of a 2 seat sofa, which is our best-selling configuration.
- If a 1 seat without armrests is ordered, the control panel will be on the left side of the seat cushion, seen from front. This is standard for all modules except from the modules with armrest right.

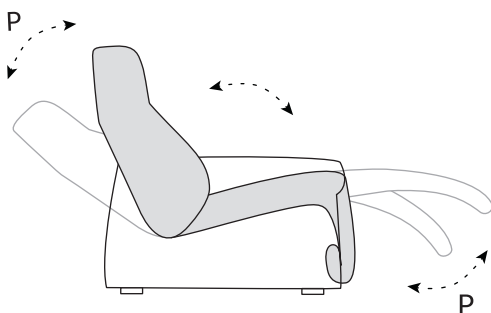

With a light pressure on the control panel, elegantly concealed at the side of the seat cushion, Power adjusts both the footrest and the back angle. You can also adjust the headrest angle. This combination provides superb support and comfort.

Improved electrical connection

- We have upgraded the power supply and battery to enable powering up to 3 seats per power supply/battery.



Only one power supply is needed per 3 seats with Power.
Easy access to the electrical connection between the modules.



Easy 2-pin connection at the back frame of the sofa for the modules with Power supply.

- The first module from the left (seen from front) will have a power supply unit that also supplies the following two power units.
- The fourth Power seat module from the left must have a Power supply unit.

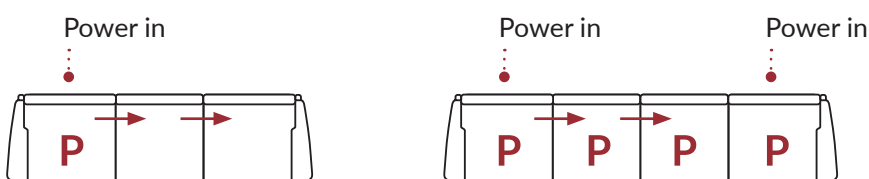

→ = Power Connections



Guide for ordering Stressless® Mary v2

- The most common configurations of Stressless® Mary v2 can be ordered as pre-configured setups, available with one SKU. The number of power supplies and placement of these are pre-defined and no specification is needed.

The examples below shows Stressless® Mary v2 Wood

— 112 —



Chair P
1453811

— 188 —



**2 Seater
2s PD**
1453821

— 188 —



**2 Seater
2s PP**
1453822

— 264 —



**3 Seater
3s**
1453030

— 264 —



**3 Seater
3s PDP**
1453832

— 340 —



**4 Seater
4s PDDP**
1453868

- The battery is sold separately. You must order one battery per Power supply.
- Unique configurations that are not available with a single SKU can be ordered by module. It's important to specify which modules should have a power supply, as explained on the next page.

Important Information when Ordering Single Modules

- It is important to know how the final set up will look because every fourth power seat unit will require a power supply.
- Always start counting from the left hand facing seat. The first power module to the left must have power supply, after three Power seat modules you will need to order the next Power seat module with a power supply.
- Power seat modules with left hand facing arms will have a power supply as standard.
- Do not include dummy seats when you count the number of power seats. If you have a set up with Power-Dummy-Power-Dummy-Power, you still only need one power supply for the set up (three power seats).

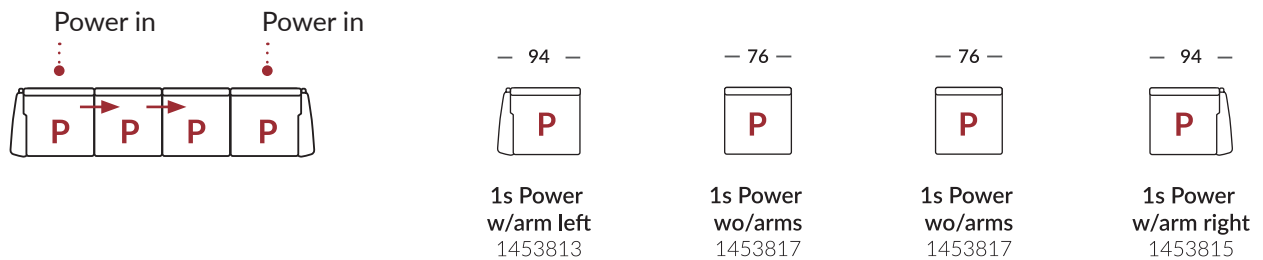

Change in assembly, Stressless® Mary v2

- New packing solution: backrest and seat will be packed separately.
- Easy snap-on assembly of the backrest (no tools needed).
- Individual packing of backrest and seat makes shipping and handling easier, with reduced volume and weight of each box.



- The new assembly solution makes it easier to install the battery.
- New pocket solution for the battery, attached with Velcro to the frame.



* Pictures used for illustration purposes only, the process is the same for Stressless® Mary.









Measurements Stressless® Mary v2 Upholstered Arm

Arm height: 59 cm
 Seat height: 46 cm
 Seat depth: 59 cm
 Sofa height: 102 cm
 Depth upright: 99 cm
 Depth reclined: 173 cm
 Distance to wall: minimum 23 cm



Separate modules for customized configurations

— 96 — 	— 76 — 	— 96 — 	— 96 — 	— 76 — 	— 96 — 	— 20 — 
1s w/arm left 1453012	1s wo/arms 1453014	1s w/arm right 1453013	1s Power w/arm left 1453813	1s Power wo/arms 1453817	1s Power w/arm right 1453815	Armrest

Configurations

Modules with and without Power can be combined in a large number of setups. The illustrated setups are examples of popular combinations.

Abbreviations
 D: Dummy (no Power)
 P: Power

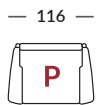

Chair P
1453811

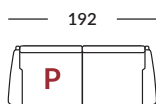

2 Seater
2s PD
1453821

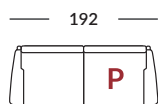

2 Seater
2s DP
Order as separate modules

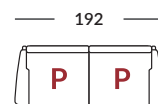

2 Seater
2s PP
1453822



3 Seater
3s
1453030



3 Seater
3s PDP
1453832

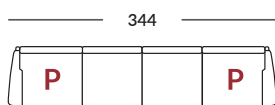

4 Seater
4s PDDP
1453868







* All measurements in cm. Sizes of individual products may vary by up to 3 cm due to the handmade nature of the product.

Measurements Stressless® Mary v2 Wood Arm

Arm height: 61 cm
 Seat height: 46 cm
 Seat depth: 59 cm
 Sofa height: 102 cm
 Depth upright: 99 cm
 Depth reclined: 173 cm
 Distance to wall: minimum 23 cm



Separate modules for customized configurations

— 94 — 	— 76 — 	— 94 — 	— 94 — 	— 76 — 	— 94 — 	— 18 — 
1s w/arm left 1453012	1s wo/arms 1453014	1s w/arm right 1453013	1s Power w/arm left 1453813	1s Power wo/arms 1453817	1s Power w/arm right 1453815	Armrest

Configurations

Modules with and without Power can be combined in a large number of setups. The illustrated setups are examples of popular combinations.

Abbreviations
 D: Dummy (no Power)
 P: Power



Chair P
1453811

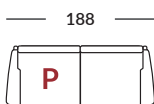

2 Seater
2s PD
1453821

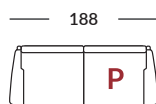

2 Seater
2s DP
Order as separate modules

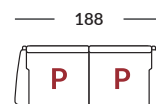

2 Seater
2s PP
1453822



3 Seater
3s
1453030



3 Seater
3s PDP
1453832

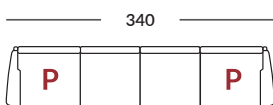

4 Seater
4s PDDP
1453868

* All measurements in cm. Sizes of individual products may vary by up to 3 cm due to the handmade nature of the product.

